

Hand Operated Curtain Track System

Silent Gliss® 1021

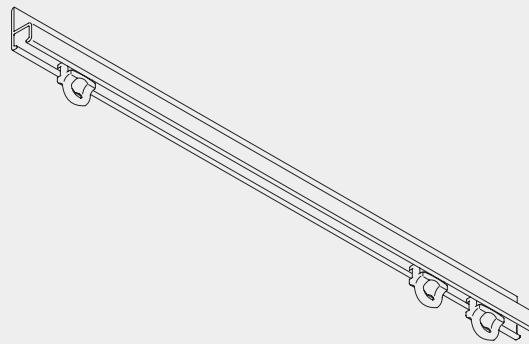

Product Information

- Discreet wall fix hand operated curtain track for light curtains and nets
- Widely used for aircraft, trucks, boats, caravans, etc
- Ideal for mounting directly on to window frames/doors or wooden batten
- Pre-drilled every 300mm
- Standard colours: silver, white.
- Standard profile lengths: 5m silver only, 6m all colours
- Can be bent



1021

Profile, Bending and Specification Information

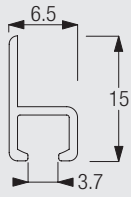

1021



Standard radius 100mm

The standard radius is recommended for optimal operation. The minimum possible radius is 60mm.

Specification Guide - download from Silent Gliss Extranet

Silent Gliss 1021 curtain track, hand-drawn, anodised aluminium, complete with gliders 3533 at 16/m. and 2 stops 3016 per length, face fixed level with under-side timber batten (by others) at 300mm. centres with special screw 6835.Lm.

Fitting Information

Fixing points



The fixing distances are meant as a guide only: they may vary in practice depending on surface and curtain weight.

Fitting Options

Face fix profile



1021

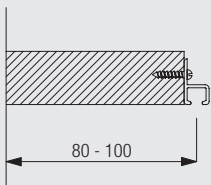

Fixing profile underneath

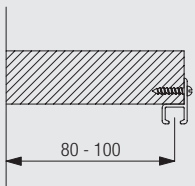

The final distances may be outside of the recommendations above depending on curtain heading, make-up and any obstructions. Batten thickness depends on length of screw.

Standard Accessories

1021 Profile



3016 Endstop



3534 Glider 3533 in strip form



6835A Special roundhead screw 12mm No. 4

Optional Accessories

3017 Endstop



3032 Spring stop



3070 Twist eye endstop



3071 Screw twist endstop



3511 Glider



3533 Glider



3548 Retrofit glider



3570 Rotating glider



3580 Side mounted glider/hook



10430 Draw rod with hook, 50cm



10431 Draw rod with hook, 75cm



10432 Draw rod with hook, 100cm

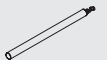

10433 Draw rod with hook, 125cm



10434 Draw rod with hook, 150cm

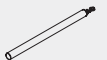

6835B Special roundhead screw 24mm No.4

6835C Pozidrive screw 12mm No.4



1021

Useful Information and Sewing Accessories

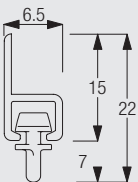

Diagram uses standard 3533/3534 glider and is measured to the inside of the glider eye. For optional gliders substitute dimensions below:

3570 = 6.0mm

3548 = 7.5mm

3068 Loop tape



3562 Standard tape

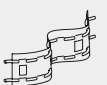

3571 Hook



3582 Hook



Supplied by



www.sg-s.co.uk email: sales@sg-s.co.uk tel: 01395 232528

www.silentgliss.co.uk

www.silentglissglobal.com

Silent Gliss Ltd
Pyramid Business Park
Poorhole Lane
Broadstairs
Kent
CT10 2PT
Great Britain

Tel: +44 (0) 1843 863571
Fax: +44 (0) 1843 864503
info@silentgliss.co.uk

Silent Gliss Global Ltd
Pyramid Business Park
Poorhole Lane
Broadstairs
Kent
CT10 2PT
Great Britain

Tel: +44 (0) 1843 874250
Fax: +44 (0) 1843 874457
info@silentglissglobal.com