

Hand Operated Curtain Track System

Silent Gliss® 6243

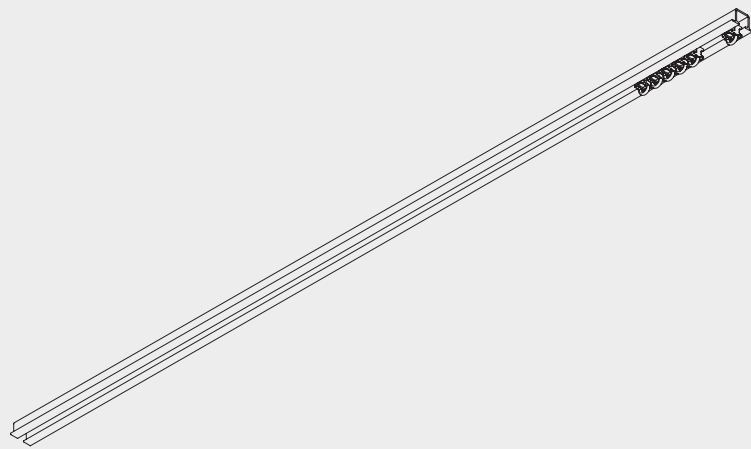

Product Information

- Operation: hand drawn
- Range: M
- Fitting: recess
- Colours: white
- Shape: square
- 2C glider technology
- Wave compatible
- Bendable



6243

Profile and Bending Information

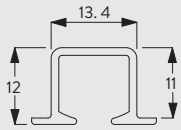

6243



Min. radius 25cm

Specification Guide

Silent Gliss 6243 curtain track, hand-drawn, anodised aluminium, complete with gliders 6096 at 16/m. 1 end stop 6065 and 1 spring stop 6053 per length. Top fixed with punched holes every 200mm.

Fitting Information

Fixing points

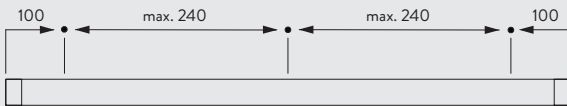

The fixing distances are meant as a guide only: they may vary in practice depending on surface and curtain weight.

Stack Depth Wave Standard

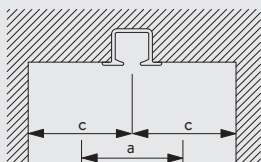
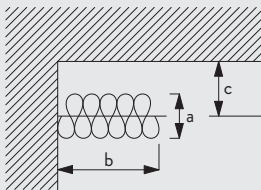

a = Stack depth
b = Stack size
c = Min. distance

Glider-cord spacing	Curtain hook spacing	Approx. curtain fullness	Stack depth (a)	Stack width (b)	Min distance (c)
6	10	2.1	10	23 per metre of track + endpiece	8
6	12	2.3	12	23 per metre of track + endpiece	9
8	14	2.1	14	18 per metre of track + endpiece	10
8	16	2.3	16	18 per metre of track + endpiece	11

Wave standard with roller gliders

Glider-cord spacing	Curtain hook spacing	Approx. curtain fullness	Stack depth (a)	Stack width (b)	Min distance (c)
8	14	2.1	14	21 per metre of track + endpiece	10
8	16	2.3	16	21 per metre of track + endpiece	11

(dimensions in cm)

Note: Minimum distance (c) includes a standard 3cm clearance (front and back).

System Options

Wave Standard curtain heading system

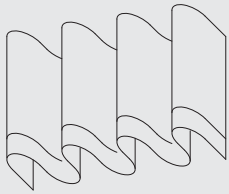

Wave is an exciting new contemporary curtain heading system which allows curtains to hang in a continuous wave which is smooth, simple and elegant.

When using the Wave curtain heading system please note that the maximum recommended curtain weight is 2.5kg/m or 10kg/m with wave roller glider 6099.

The Wave Standard components are:

11303 Glider-cord 60mm
11305 Glider-cord 80mm
6007 End stop

The items listed below are all supplied at an additional cost as per the price list:

Wave hardware components for Enhanced Wave (80mm glider cord only) are:

2255 Adjustable brake
6364 Extension (used with 6365)
6365 Hanger (used with 6364)
6366 Carrier for draw rod

Roller gliders 6099 must be ordered separately:

Optional enhanced components to improve the presentation of the curtain:

3582 Hook
6349 Wave curtain tape
6363 Iron on top hemming tape
10075 Lead weight for hem of curtain 50 gr/m
10076 Fabric weight for side edge of curtain

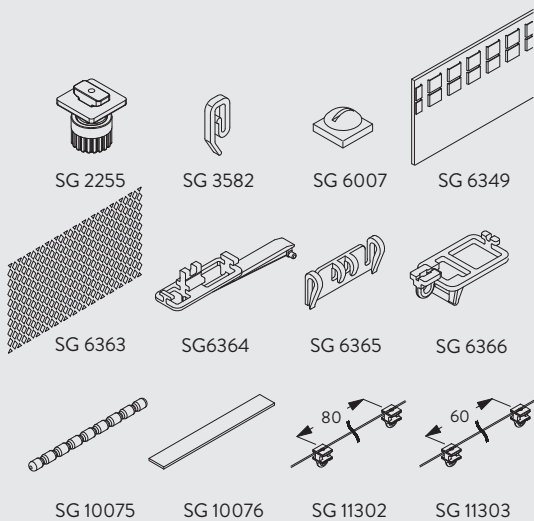

Fitting Options

CAD download through Silent Gliss e-catalogue

Recess ceiling fix

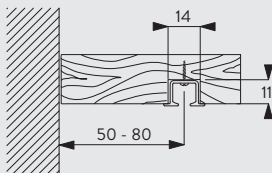

The final distances from the wall depend on curtain weight, make-up and any obstructions. The profile is punched every 200mm.

Standard Accessories

0240 Screw

6053 Spring stop



6065 Twist eye endstop 

6096 Glider 6083 in strip form 

6243 Profile 

7002 Profile protector 

11301 2C glider 11300 on strip (x20) 

Optional Accessories

3067 Connecting bridge 

3582 Hook 

6086 Spring stop 

Wave Accessories

2255 Adjustable brake 

6099 Wave roller glider cord (80mm) 

6349 Curtain tape 

6363 Top hemming tape 

6364 Extension 

6365 Hanger 

6366 Wave carrier for draw rod 

10075 Lead weight 50 gr/m 

10076 Fabric weight 

11302 Wave 2C glider cord 80 mm 

11303 Wave 2C glider cord 60 mm 

6243

Supplied by



www.sg-s.co.uk email: sales@sg-s.co.uk tel: 01395 232528

www.silentgliss.co.uk

www.silentglissglobal.com

Silent Gliss Ltd
Pyramid Business Park
Poorhole Lane
Broadstairs
Kent
CT10 2PT
Great Britain

Tel: +44 (0) 1843 863571
Fax: +44 (0) 1843 864503
info@silentgliss.co.uk

Silent Gliss Global Ltd
Pyramid Business Park
Poorhole Lane
Broadstairs
Kent
CT10 2PT
Great Britain

Tel: +44 (0) 1843 874250
Fax: +44 (0) 1843 874457
info@silentglissglobal.com