

Heavy Duty and Stage Curtain Track System

Silent Gliss® 6370

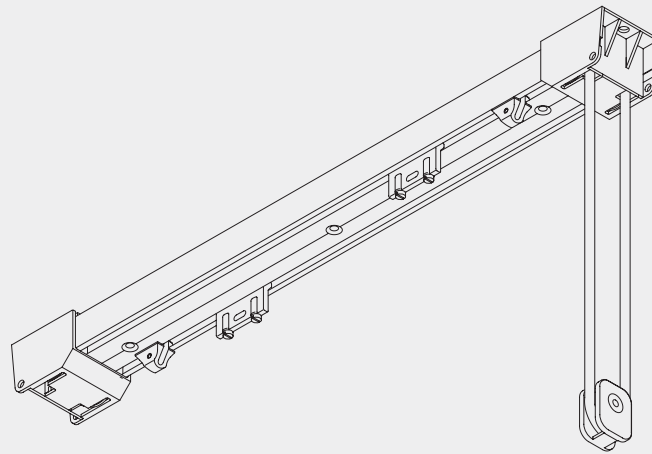

Product Information

- Discreet heavy-duty track system with twin channel for infinite overlap
- Cost effective system for small stages, very heavy contract and domestic use etc
- Heavy curtains up to 70kg, and width up to 15m
- Simple direct fixing, ceiling fix preferred. Drilled at approximately 500mm centres
- Profile available in 4, 5 and 6 metre lengths
- Satin silver finish as standard
- Can be bent



6370

Profile, Bending and Specification Information

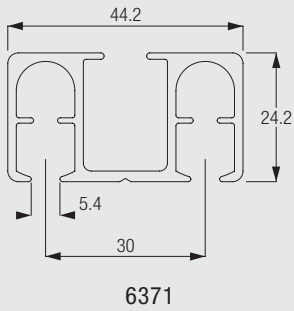

Specification Information - download from www.silentgliss.co.uk (password required).

Silent Gliss 6370 curtain track, cord operated, assembled complete with roller gliders 6098 at 10/m. cord 6070 with cord drop 3000mm right-hand side, ceiling fixed through profile at 500mm centres plus endpieces, each one screwed to timber/plugged and screwed to brickwork/ concrete.Lm inlengths.

How to Measure

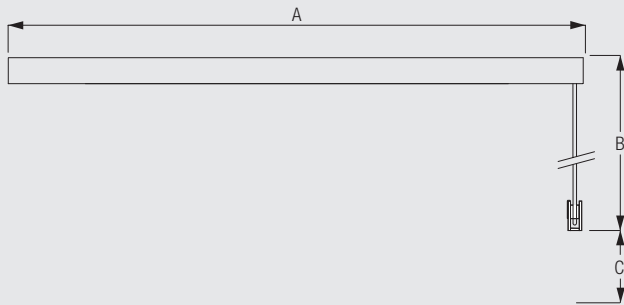

A: system width
 B: cord height
 C: cord retainer 10400 must be installed at least 150cm above the floor
 (ref: EN13120 Child Safety)

System Dimensions



6370



15 m



70 kg

Maximum curtain weight chart (with roller)

	3 m	6 m	9 m	12 m	15 m
	65	60	55	50	45
	70	65	60	55	50
	48	42	36	31	26
	54	48	42	36	30
	38	32	27	22	18
	44	38	32	27	22
	24	15	5	-	-
	27	19	10	-	-
(kg max.)					

Fitting Information

WARNING

Young children can be strangled by loops in pullcords, chains, tapes and inner cords that operate the product. To avoid strangulation and entanglement, keep cords out of the reach of young children. Cords may become wrapped around a child's neck. Move beds, cots and furniture away from window covering cords. Do not tie cords together. Make sure cords do not twist to create a loop.

Bracket positioning

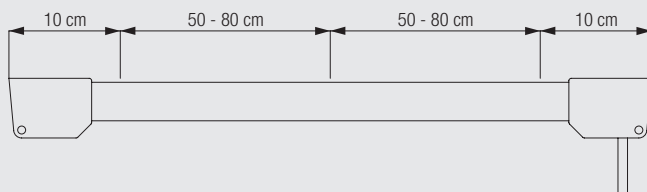

The fixing distances above are meant as a guide only, they may vary in practice depending on surface and curtain weight. For particularly heavy curtains the maximum recommended distance is 500mm.



6370

Fitting Options

CAD download through Silent Gliss website (password required) www.silentgliss.co.uk

Direct to ceiling fix through profile

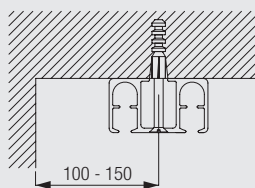

Recess fix through profile

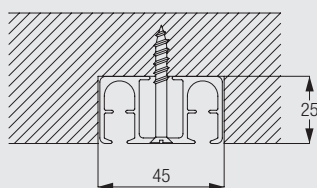

Wall fix with bracket 3239

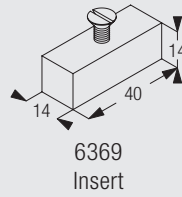
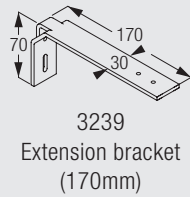
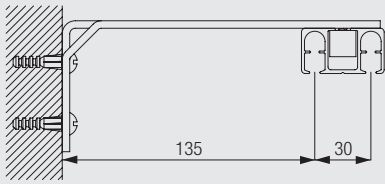

Brackets feature thread for screw M4x30 for fixing

Standard Accessories

18R	Screw 25mm. No. 8 roundhead		6070	Cord (ø 6mm)	
6086	Spring stop		6098	Roller glider with eye	
6214	Adjustable pilot (white)		6227	Master pilot runner (grey)	
6371	Profile		6377	Endpiece set (2 part)	
10400	Safety Cord Retainer		1128C	Countersunk screw	

Optional Accessories



6370

0558	Screw M4 30mm c/sunk pozidrive		3239	Extension bracket (170mm)	
6007	Endstop		6079	Overlap arm	
6094	Roller glider with hook		6369	Insert	
6376	Connecting bridge				

Sewing Information and Accessories

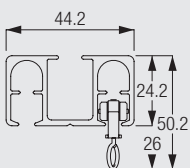

Diagram uses standard roller 6098 measured to the inside of the glider eye. For optional rollers substitute the dimensions below:

6094 = 31mm

3582 Hook



3599 Hook



6370



www.silentgliss.co.uk

www.silentglissglobal.com

Silent Gliss Ltd
Pyramid Business Park
Poorhole Lane
Broadstairs
Kent
CT10 2PT
Great Britain

Tel: +44 (0) 1843 863571
Fax: +44 (0) 1843 864503
info@silentgliss.co.uk

Silent Gliss Global Ltd
Pyramid Business Park
Poorhole Lane
Broadstairs
Kent
CT10 2PT
Great Britain

Tel: +44 (0) 1843 874250
Fax: +44 (0) 1843 874457
info@silentglissglobal.com