

Chain Operated Venetian Blind System

Silent Gliss® 8300

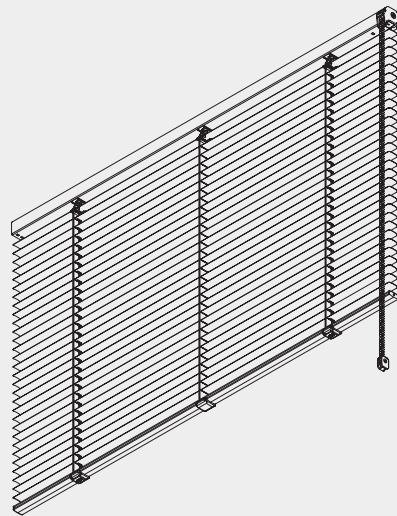

Product Information

- Mono controlled, chain operated venetian blind system for 16mm or 25mm aluminium slats
- One single metal chain controls raising/lowering of slats and tilting. Left or right hand operation
- Available in 77 different slat colours. Also perforated slats available for 25mm slats
- The control mechanism on the front of the headrail not only offers easy access and operation but also enables side-by-side mounting of systems with a minimized light gap
- The system 8300 can be equipped with side-guide wires and can therefore be used for sloped applications up to 15° incline from vertical
- Easily fitted with snap brackets to ceiling or wall
- Optional integral Child Safety Device



8300

Supplied by

SG-S | Silent Gliss Spares
Silent Gliss Systems

www.sg-s.co.uk email: sales@sg-s.co.uk tel: 01395 232528

Profile Information, Bending and Specification Information

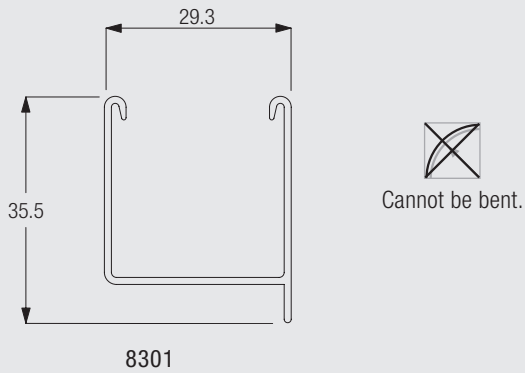

Specification Information - download from www.silentgliss.co.uk (password required).

Silent Gliss 8300 system mono controlled chain operated venetian blind. Overall widthcm, overall dropcm. Single chain operation RHS / LHS. Aluminium headrail to incorporate flange to minimise light ingress at top of blind. Slat colour(s) to be chosen from Silent Gliss 16mm / 25mm range. System is to be fixed with snap-on-brackets 8302 to ceiling / wall at 800-1000mm intervals plus one at 70mm from each end.

System Dimensions and Slat Stack Height



3m



50cm



3m



4.5m²

Slat stack height calculation

Slat Width (mm)	X	Slat Stack Height (cm)										
		50	75	100	125	150	175	200	225	250	275	300
16	X	6.6	7.5	8.4	9.3	10.2	11.1	12.0	12.9	13.8	14.7	15.6
25	X	6.7	7.5	8.2	9.0	9.8	10.5	11.3	12.0	12.8	13.6	14.3

Please note that the indicated stack heights may vary by up to 1cm.

System Options

Side guides for stabilising blind system and sloped applications (up to 15° from vertical)

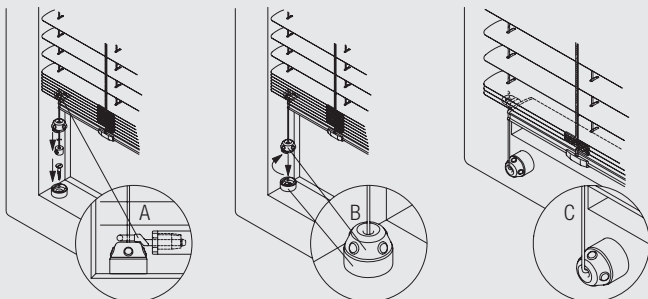

A and B: Fitting of side guides inside window frame
(A: detail eyelet / B: detail wireholder)
C: Fitting of side guides onto front of window frame

The system 8300 can be equipped with side-guide wires and can therefore also be used for sloped applications up to 15° incline from vertical.

Child Safety Device

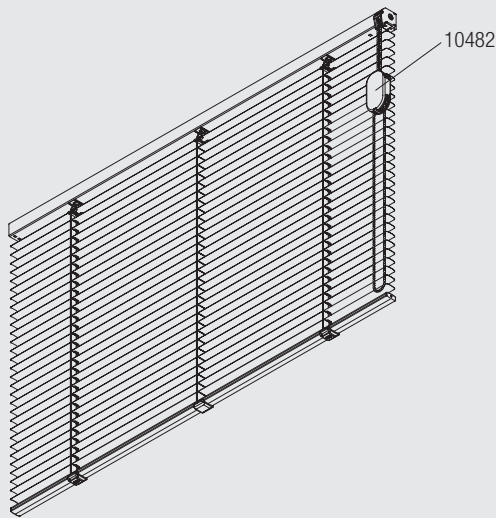

The child safety device SG 10482 releases the chain should the pulling force exceed 6kg.

The max. system surface should not exceed 3.5m². Only applicable with 25 mm slats.

Fitting Information

WARNING

Young children can be strangled by loops in pullcords, chains, tapes and inner cords that operate the product. To avoid strangulation and entanglement, keep cords out of the reach of young children. Cords may become wrapped around a child's neck. Move beds, cots and furniture away from window covering cords. Do not tie cords together. Make sure cords do not twist to create a loop.

Bracket positioning

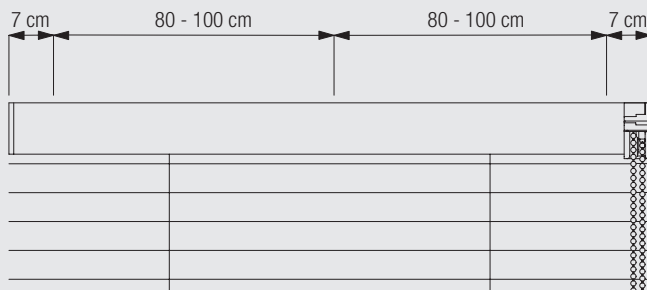

8300

Side gaps when side-by-side fitting or recess fitting

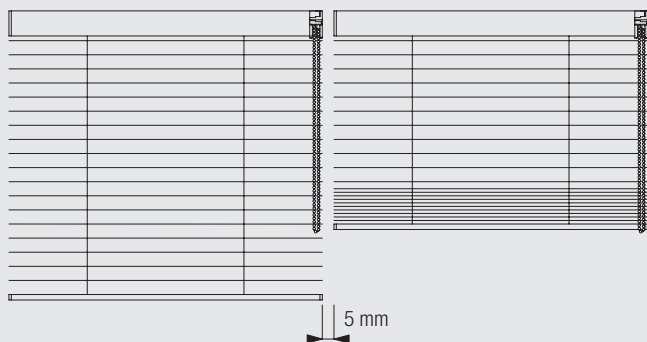

The light gap between two systems is 5mm when fitted side-by-side.

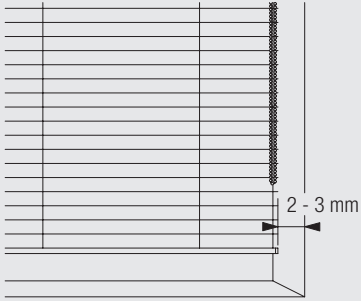

Distance from wall when recess fitting is 2-3mm.

Fitting Options

Ceiling fix with bracket 8302

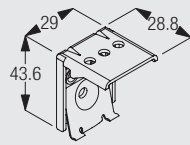
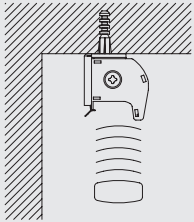

8302
Bracket

Recess fix with bracket 8302

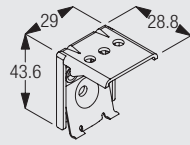
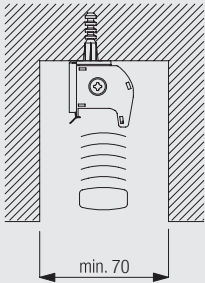

8302
Bracket



8300

Wall or window frame fix with bracket 8302

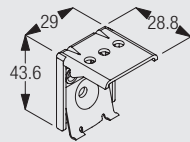
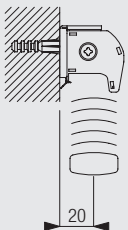

8302
Bracket

Wall fitting with Smart Fix 11200-11201 and bracket 8302

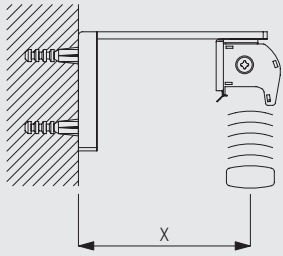

	X (mm)
11200	59
11201	79

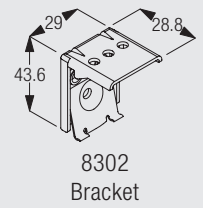
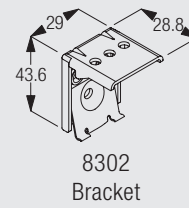
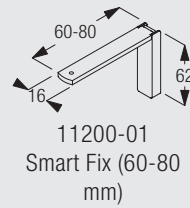

Brackets feature thread for screw SG 10395 (M4x6) for fixing bracket SG 8302.

Wall fitting with Square Smart Fix 11210-11211 and bracket 8302

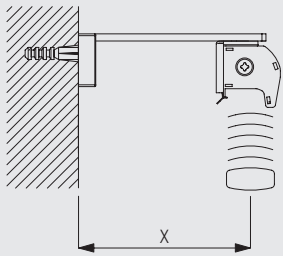

	X (mm)
11210	59
11211	79

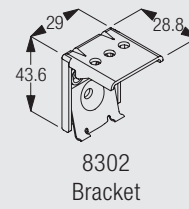
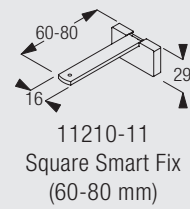

Brackets feature thread for screw SG 10395 (M4x6) for fixing bracket SG 8302.

Wall fitting with Universal Smart Fix 11154-11156 and 8302

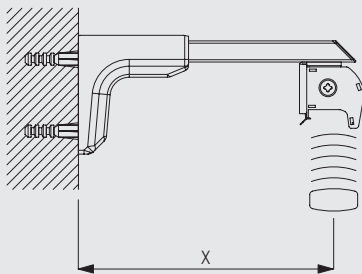

	X (mm)
11154	109-137
11155	139-167
11156	189-217

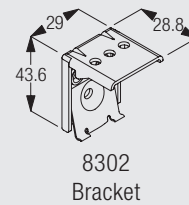
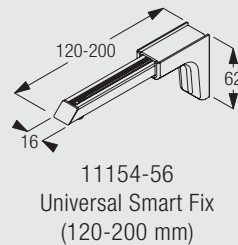

Brackets feature thread for screw SG 10407 (M4x10) for fixing bracket SG 8302.



Standard Accessories

8003 Bottom bar (16mm slats)



8004 Bottom bar (25mm slats)



8301 Profile



8302 Bracket



10400 Safety Cord Retainer



10530 Stainless steel bead chain (ø 4mm)



Optional Accessories

8235 Wire base short



8236 Wire base long



8237	Wire holder		8241	Eyelet	
8249	Locking ring		8262	Spacer (10°)	
8263	Spacer (4°)		10120	Wire ø 0.9 mm for side guide	
10482	Child Safety device - 4mm Metal Bead Chain		11154	Universal Smart Fix, 120 mm set	
11155	Universal Smart Fix, 150 mm set		11156	Universal Smart Fix, 200 mm set	
11200	Smart Fix, 60 mm set		11201	Smart Fix, 80 mm set	
11210	Square Smart Fix, 60 mm set		11211	Square Smart Fix, 80 mm set	

Useful Measures

8003 Bottom bar (16mm slats)

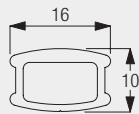

8004 Bottom bar (25mm slats)

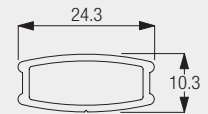

10482 Child Safety device - 4mm Metal Bead Chain

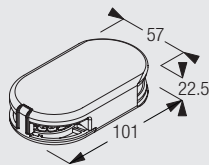

8300

Supplied by

SG-S | Silent Gliss Spares
Silent Gliss Systems

www.sg-s.co.uk email: sales@sg-s.co.uk tel: 01395 232528

Silent Gliss®

Supplied by



www.sg-s.co.uk email: sales@sg-s.co.uk tel: 01395 232528

www.silentgliss.co.uk

www.silentglissglobal.com

Silent Gliss Ltd
Pyramid Business Park
Poorhole Lane
Broadstairs
Kent
CT10 2PT
Great Britain

Tel: +44 (0) 1843 863571
Fax: +44 (0) 1843 864503
info@silentgliss.co.uk

Silent Gliss Global Ltd
Pyramid Business Park
Poorhole Lane
Broadstairs
Kent
CT10 2PT
Great Britain

Tel: +44 (0) 1843 874250
Fax: +44 (0) 1843 874457
info@silentglissglobal.com